



madibaBuggy



Organisation: _____ Date: DD MM YYYY

Client name: _____

Therapist: _____

Technician to call the therapist BEFORE making this device: No Yes

Due Date: DD MM YYYY

Key: Tickbox Upcharge Item

* The tables are a size reference guide for standard items.

BASE OPTIONS*

*Refer to Product Flyers for more base frame details.

* Refer to Power Base spec sheet for more options.



Rigid 10 Buggy Base (All Sizes)



Rigid 20 Buggy Base (Small, Medium, Large Only)



Folding 10 Buggy Base (Baby1, Baby2, Small, Medium Only)



Power Base (All Sizes)

Optional: Rigid 20 Base Axle Position: 50mm Set Back Axle 100mm Set Back Axle

SEATING SYSTEM

	BABY 1 <input type="checkbox"/>	BABY 2 <input type="checkbox"/>	SMALL <input type="checkbox"/>	MEDIUM <input type="checkbox"/>	LARGE <input type="checkbox"/>
Seat width	280mm	280mm	330mm	330mm	430mm
Seat length range	250mm	290mm	390mm	450mm	485mm
Backrest height	400mm	400mm	490mm	540mm	550mm
Back to seat angle	100°	100°	100°	100°	100°
Upholstery Colour	Smiling Kids Print	Smiling Kids Print	Smiling Kids Print	Royal Blue	Navy Blue

* **Please note:** Measurements are the max usable buck dimensions with seat cushion only. No other cushions.

UPHOLSTERY

- Optional:** Alternative CoverAll seat cover (waterproof fabric)
- Optional:** Additional cover set (Includes cushion cover)
- Optional:** Alternative colour or pattern (please inquire with Shonaquip on current available colour options)
- Optional:** Alternative fabric (please inquire with Shonaquip on current available fabric options)



SEATING CUSHIONS

	BABY 1	BABY 2	SMALL	MEDIUM	LARGE
Cushion - W x D x H	280 x 240 x 80mm	280 x 300 x 80mm	320 x 390 x 100mm	320 x 490 x 100mm	420 x 500 x 100mm
Cushion Foam	30mm HD & 50mm Chip	30mm HD & 50mm Chip	50mm HD & 50mm Chip	50mm HD & 50mm Chip	50mm HD & 50mm Chip
Abduction Block - H x D x W Fixed	90 x 850 x 90mm	90 x 850 x 90mm	100 x 130 x 100mm	120 x 180 x 100mm	120 x 180 x 100mm
Waterproof Cover	blue	blue	blue	blue	black

- Optional:** Black waterproof seat cover
- Optional:** Additional cover ____Qty

Optional: Cushion Customisation

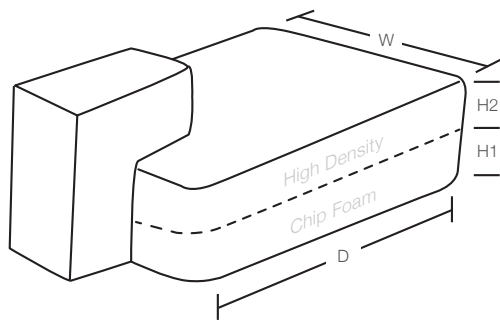

D _____ mm

W _____ mm

H1 _____ Chip Foam

H2 _____ High Density

Optional: Seat Wedge Full Length

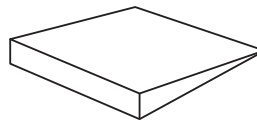

25mm 50mm

- Optional:** Removable Abduction Block
- Optional:** No Abduction Block
- Optional:** Abduction Block Customisation

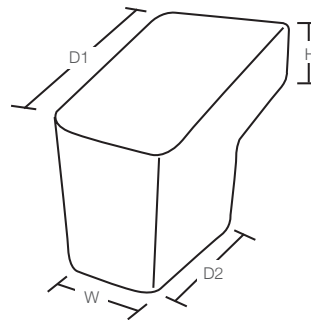

H _____ mm

D1 _____ mm

D2 _____ mm

W _____ mm

BACK CUSHION

	BABY 1	BABY 2	SMALL	MEDIUM	LARGE
High Density Foam Thickness	2 x 25mm	2 x 25mm	2 x 25mm 1 x 50mm	2 x 25mm 1 x 50mm	2 x 25mm 1 x 50mm

- Optional:** Extra Back Cushion 25mm High Density ____Qty 50mm High Density ____Qty
- Optional:** Additional Cover 25mm ____Qty 50mm ____Qty
- Optional:** Lycra on front face of front cushion cover



TRUNK SIDE SUPPORTS

	BABY 1	BABY 2	SMALL	MEDIUM	LARGE
Padding Thickness	45mm	45mm	50mm	50mm	50mm
Size - H x D	200 x 140mm	200 x 140mm	240 x 210mm	300 x 240mm	340 x 280mm

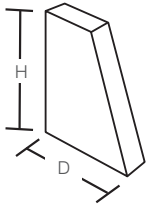

Optional: Lycra inside panel both side supports

Optional: Custom Trunk Side Support Height _____ mm

Depth _____ mm

Thickness _____ mm

STRAPS

	BABY 1	BABY 2	SMALL	MEDIUM	LARGE
Pelvic Strap	Size 1	Size 1	Size 4	Size 4	Size 5
Chest Strap round	Size 1	Size 1	Size 2	Size 2	Size 3
Knee Strap	Size 1	Size 1	Size 2	Size 2	Size 3
Thigh Strap	Size 1	Size 1	Size 2	Size 2	Size 3

Select: Pelvic Strap (W x L Padding)

Size **1:** 30 x 180mm **2:** 40 x 200mm **3:** 40 x 260mm **4:** 40 x 300mm **5:** 70 x 270mm

Optional: Chest Strap round (Padding Diameter)

Size **1:** 100mm **2:** 120mm **3:** 140mm

Optional: Knee Strap (W x L Padding)

Size **1:** 55 x 280mm **2:** 70 x 340mm **3:** 80 x 440mm

Optional: Thigh Strap (W x L Padding)

Size **1:** 55 x 280mm **2:** 70 x 340mm **3:** 80 x 440mm

Optional: Custom strap (Refer to Special Instruction page)

**Remember to indicate:

- Webbing widths and lengths.
- Foam padding type, widths, lengths and thickness.
- Types of buckles to use.
- Draw a diagram where possible.



HEADREST

	BABY 1	BABY 2	SMALL	MEDIUM	LARGE
Madiba Head Cushion	Size 1	Size 1	Size 2	Size 2	Size 2
Madiba2Go	Size 1	Size 1	Size 2	Size 3	Size 3
Mitt	Size 1	Size 1	Size 2	Size 2	Size 2

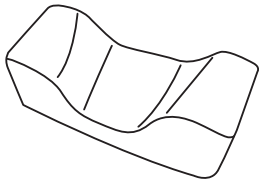

Madiba Head Cushion

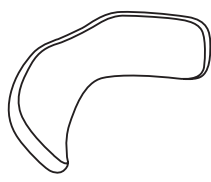

Mitt

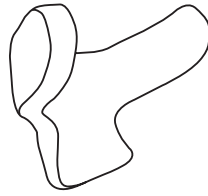

Madiba2Go

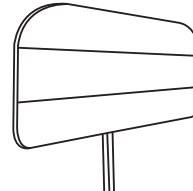

Head Cushion Back Board

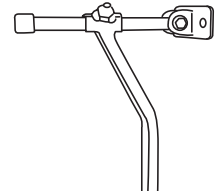

Forward Adjustable Extension

Optional: Cover with Lycra front panel

Select: Headrests (W x D)

Madiba 1: 160 x 55mm

Madiba 2: 170 x 70mm

Mitt 1: 190 x 88mm

Mitt 2: 230 x 103mm

M2Go 1: 145 x 70mm

M2Go 2: 170 x 90mm

M2Go 3: 190 x 95mm

Upright Adjustable Extension

Fit Dual Extensions

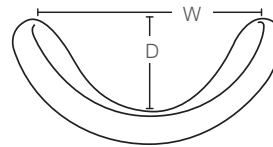

FOOTBOX

	BABY 1	BABY 2	SMALL	MEDIUM	LARGE
Footbox - W x D x H	265 x 150 x 50mm	265 x 150 x 50mm	290 x 180 x 90mm	290 x 180 x 90mm	290 x 180 x 90mm
Footbox hanger angle	95°	95°	110°	110°	110°
Footbox adjustment range (Footbox to top of seat cushion)	140 - 300mm	140 - 300mm	230 - 370mm	240 - 440mm	220 - 420mm

Optional: Custom Footbox

Optional: Footbox Raiser
(Only available on S, M, L sizes)

Optional: Custom Footbox Hanger

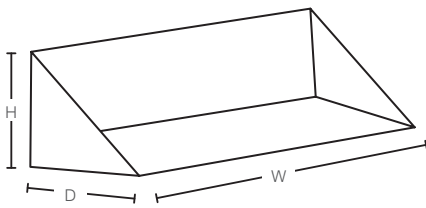

W _____ mm

D _____ mm

H _____ mm

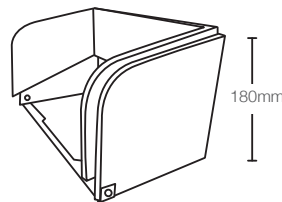

Optional: Foam Lining

EVA black foam

Soft blue foam

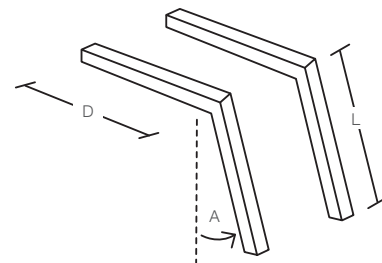

D _____ mm

L _____ mm

A _____ Angle °

LAPTRAY

	BABY 1 & 2	SMALL/MEDIUM	LARGE
Size - width x depth	460mm x 210mm	575mm x 255mm	685mm x 290mm

Select: Side Mount Tray

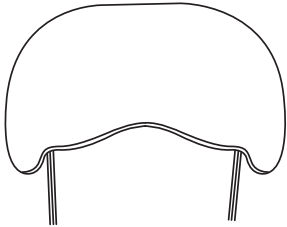

Madiba Tray

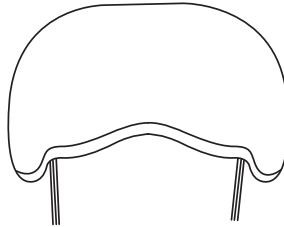

Padded Tray

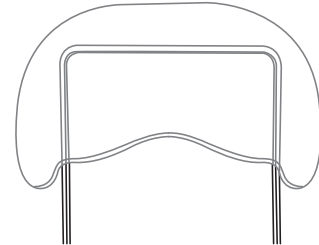

Lexan Tray

Optional: Slide depth adjuster for tray

Optional: Centre Mount Tray
(works with custom footbox setup only)

Optional: Forearm cuff

LEFT

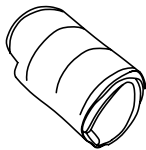

L _____ mm
W _____ mm

RIGHT

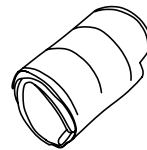

L _____ mm
W _____ mm

