



# samActive



Organisation: \_\_\_\_\_ Date:     DD     MM     YYYY

Client name: \_\_\_\_\_

Therapist: \_\_\_\_\_

**Technician to call the therapist BEFORE making this device:** No  Yes

Due Date:     DD     MM     YYYY

**Key:**  Tickbox  Upcharge Item

\* The tables are a size reference guide for standard items.

## BASE OPTIONS

\*Refer to Product Flyers for more base frame details.



Rigid 24 Active Base  
(All Sizes excl. 20")



Rigid 10 Manual Base  
(Sizes 12" - 20")



Power Base  
(All Sizes)

\*Refer to Power Base spec sheet for more information

## SEATING SYSTEM

	12"std <input type="checkbox"/>	14"short <input type="checkbox"/>	14"std <input type="checkbox"/>	16" <input type="checkbox"/>	18" <input type="checkbox"/>	20" <input type="checkbox"/>
Seat width	300mm	350mm	350mm	400mm	450mm	500mm
Standard Seat length	300 - 400mm	250 - 350mm	350 - 450mm	350 - 450mm	350 - 450mm	n/a
Extended Seat length	300 - 400mm	300 - 400mm	400 - 500mm	400 - 500mm	400 - 500mm	400 - 500mm
Tilt in space range (approx.)	20°	20°	20°	20°	20°	20°
Adjustable footrest range	300 - 450mm	300 - 450mm	300 - 450mm	350 - 500mm	350 - 500mm	350 - 500mm
Back to seat recline range	90° - 125°	90° - 125°	90° - 125°	90° - 125°	90° - 125°	90° - 125°

**Select:**  Standard Seat Length (incl. regular push handles)  
(All Sizes)

Extended Seat Length (incl. tall push handles)  
(All Sizes)

## BACK SUPPORT

Tess Back

Gibby Back  
(All Sizes excl. 20")

TAB with LATS  
(All Sizes excl. 20")

Other: \_\_\_\_\_

\* Refer to Back Support spec sheets for more information



## SEATING CUSHIONS

	12"std	14"short	14"std	16"	18"	20"
Cushion Standard - W x D x H	300 x 400 x 100mm	350 x 350 x 100mm	350 x 450 x 100mm	400 x 450 x 100mm	450 x 450 x 100mm	n/a
Cushion Extended - W x D x H	300 x 400 x 100mm	350 x 400 x 100mm	350 x 500 x 100mm	400 x 500 x 100mm	450 x 500 x 100mm	500 x 500 x 100mm
Cushion Foam	50mm chip & 50mm HD	50mm chip & 50mm HD	50mm chip & 50mm HD	50mm chip & 50mm HD	50mm chip & 50mm HD	50mm chip & 50mm HD
Waterproof Cover	Black	Black	Black	Black	Black	Black

**Optional:** Blue waterproof seat cover

**Optional:** Additional seat cover \_\_\_\_Qty

**Optional:** Cushion Customisation

**Optional:** Seat Wedge Full Length

25mm     50mm

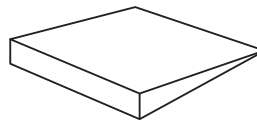

**Optional:** Custom Abduction Block

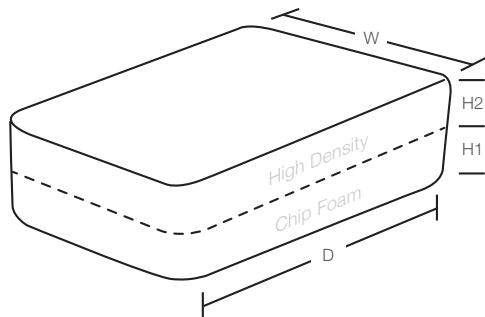

D \_\_\_\_\_ mm  
 W \_\_\_\_\_ mm  
 H1 \_\_\_\_\_ Chip Foam  
 H2 \_\_\_\_\_ High Density

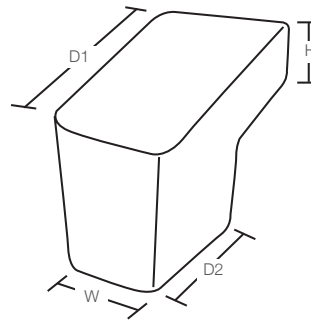

H \_\_\_\_\_ mm  
 D1 \_\_\_\_\_ mm  
 D2 \_\_\_\_\_ mm  
 W \_\_\_\_\_ mm

### SPECIALISED CUSHIONS:

Jay     Jarik     Other: \_\_\_\_\_

Specific model: \_\_\_\_\_ Size: width: \_\_\_\_\_(mm) Length: \_\_\_\_\_(mm)

## STRAPS

	12"std	14"short	14"std	16"	18"	20"
Pelvic Strap	Size 4	Size 5	Size 5	Size 5	Size 5	Size 6

**Select:** Pelvic Strap (W x L Padding)

Size:  **4:** 40 x 300 mm     **5:** 70 x 270 mm     **6:** 70 x 500 mm



## HEADREST

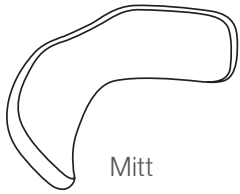

Mitt

	12"std	14"short	14"std	16"	18"	20"
Mitt	Size 2	Size 2	Size 2	Size 2	Size 2	Size 2
Kidney	Size 1	Size 2	Size 2	Size 2	Size 2	Size 2

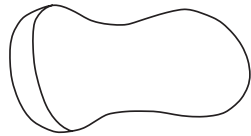

Kidney

**Select:** Headrests (W x D)

- Kidney 1: 160 x 55mm     Kidney 2: 170 x 70mm  
 Mitt 1: 190 x 88mm     Mitt 2: 230 x 103mm

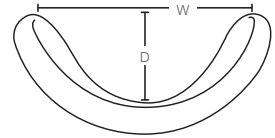

## FOOTREST

	12"std	14"short	14"std	16"	18"	20"
Footrest - W x D	288mm x 240mm	338mm x 240mm	338mm x 240mm	240mm x 388mm	438mm x 240mm	n/a
Footrest Height Range	185mm x 330mm	185mm x 330mm	185mm x 330mm	185mm x 330mm	185mm x 330mm	n/a
Footbox W x D x H	280 x 230 x 150mm	330 x 230 x 150mm	330 x 230 x 150mm	380 x 230 x 150mm	430 x 230 x 150mm	480 x 230 x 150mm
Footbox Hanger A x L	15° x 340mm	15° x 340mm	15° x 340mm	15° x 340mm	15° x 340mm	15° x 360mm

**Select:**

- Flipup Footrest

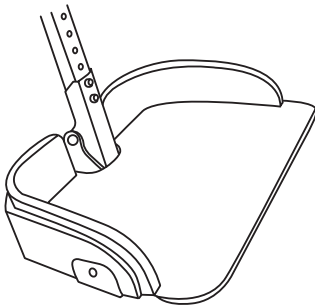

**Optional:** Custom Footrest

**Optional:** Custom Footbox

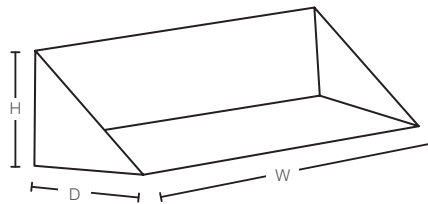

W \_\_\_\_\_ mm  
 D \_\_\_\_\_ mm  
 H \_\_\_\_\_ mm

**Optional:** Foam Lining

- EVA black foam  
 Soft blue foam

**Optional:** Custom Footbox Hanger

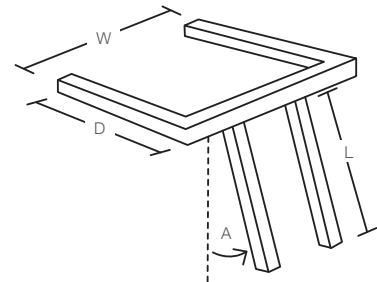

W \_\_\_\_\_ mm  
 D \_\_\_\_\_ mm  
 L \_\_\_\_\_ mm  
 A \_\_\_\_\_ Angle °

## LAPTRAY

	12"std	14"short	14"std	16"	18"	20"
Inside - W x D	310mm x 240mm	360mm x 240mm	360mm x 240mm	420mm x 240mm	420mm x 240mm	420mm x 240mm

**Select:**

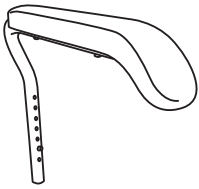

Armrest

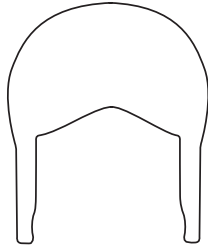

Active Tray

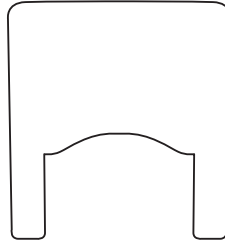

Posture Tray  
(not for active user)

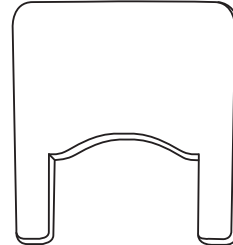

Padded Tray

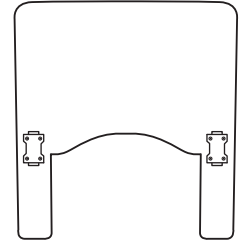

Lexan Tray

**Optional:** Additional Elbow Padding on laptray

- EVA black foam
- Soft blue foam

## CUSTOMISATIONS

---

---

---

---

---

---

---

---

---

---

